

TC

High Flow Rate/Metal Alloy Line

DESIGN FEATURES

- One-piece body with integral vanes
- Male, female, and flanged connections available

SPRAY CHARACTERISTICS

- Extremely high flow rates
- Spray pattern:** Full Cone
- Spray angles:** 60°, 90°, and 120°
- Flow rates:** 976 to 36100 L/min (Special flow rates available)

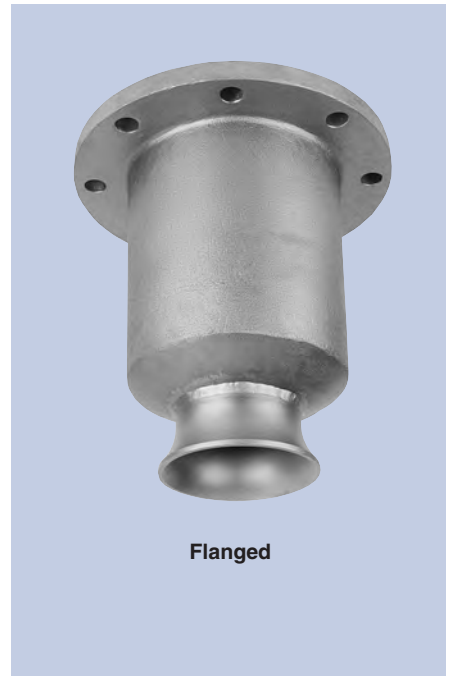

Flanged

FULL CONE

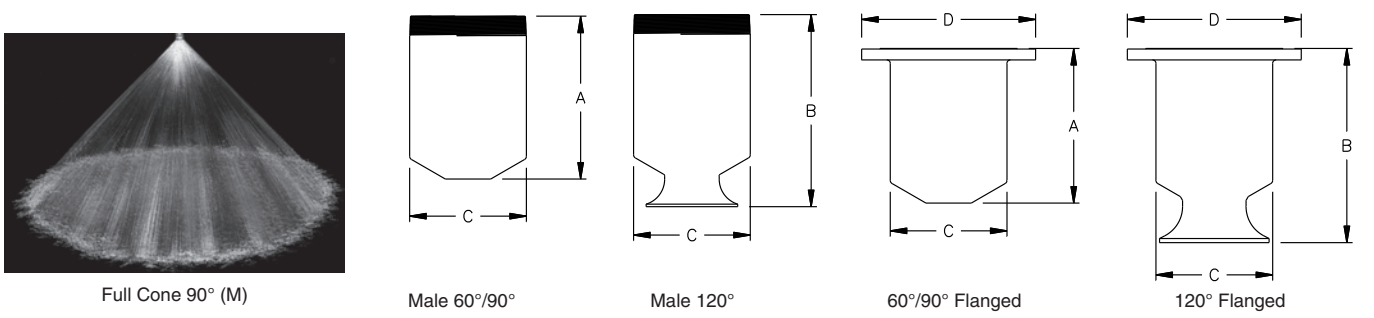

Dimensions are approximate. Check with BETE for critical dimension applications.

TC Flow Rates and Dimensions

Full Cone, Narrow 60° (N), Medium 90°(M), and Wide 120°(W) Spray Angles, 6" to 12" Pipe Sizes, BSP or NPT, 12" Flanged

Male or Female Pipe Size	Nozzle Number	Available Spray Angles	K Factor	LITERS PER MINUTE @ BAR								Approx. Free Pass. Dia. (mm)	Dimensions (mm)				Wt. (kg)
				0.1 bar	0.3 bar	0.5 bar	0.7 bar	1 bar	2 bar	3 bar	5 bar		A	B	C	D	
6	TC 532	60° 90° 120°	2820	976	1620	2050	2390	2820	3870	4670	5900	44.5	259		168	11.3	
	TC 588	90° 120°	3110	1080	1790	2260	2640	3110	4280	5160	6520		259	168			
	TC 827	90° 120°	4380	1520	2520	3180	3710	4380	6020	7250	9180		198	313	168		
8	TC 962	60° 90° 120°	5090	1770	2930	3700	4320	5090	7000	8440	10700	52.3	324		219	18.1	
	TC 1120	90° 120°	5930	2060	3410	4310	5030	5930	8150	9820	12400		324	389	219		
	TC 1260	60° 90° 120°	6670	2310	3830	4850	5660	6670	9170	11100	14000		324	389	219		
	TC 1480	90° 120°	7830	2720	4500	5690	6650	7830	10800	13000	16400		389	219			
Flanged Connection																	
6	TCFL532	60° 90° 120°	2820	976	1620	2050	2390	2820	3870	4670	5900	44.5	238		168	279	27.2
	TCFL588	90° 120°	3110	1080	1790	2260	2640	3110	4280	5160	6520		238	168	279		
	TCFL827	90° 120°	4380	1520	2520	3180	3710	4380	6020	7250	9180		238	292	168	279	
8	TCFL962	60° 90° 120°	5090	1770	2930	3700	4320	5090	7000	8440	10700	52.3	303		219	343	38.6
	TCFL1120	90° 120°	5930	2060	3410	4300	5030	5930	8150	9820	12400		303	373	219	343	
	TCFL1260	60° 90° 120°	6670	2310	3830	4850	5660	6670	9170	11100	14000		303	373	219	343	
	TCFL1480	90° 120°	7830	2720	4500	5690	6650	7830	10800	13000	16400		303	373	219	343	
12	TCFL2070	60° 90°	11000	3800	6300	7960	9300	11000	15100	18200	23000	57.2	432		483	72.6	
	TCFL2360	90°	12400	4310	7150	9040	10600	12400	17100	20600	26100		432	483			
	TCFL2510	90° 120°	13300	4610	7630	9660	11300	13300	18300	22000	27800		432	543	323		483
	TCFL2660	90° 120°	14100	4880	8090	10200	11900	14100	19400	23300	29500		432	543	323		483
	TCFL2960	90° 120°	15700	5430	9000	11400	13300	15700	21500	26000	32800		432	543	323		483
	TCFL3250	90°	17200	5960	9880	12500	14600	17200	23700	28500	36100		432	483			

CALL 413-772-0846
Call for the name of your nearest BETE representative.

$$\text{Flow Rate (L/min)} = K (\text{bar})^{0.46}$$

Standard Materials: 316 Stainless Steel

Spray angle performance varies with pressure. Contact BETE for specific data on critical applications.