

# FlexFlow™

## FLEXFLOW PRECISION SPRAY CONTROL SYSTEMS FOR AUTOMATIC SPRAY NOZZLES

BETE's FlexFlow Spray Systems ensure precision control and flexible automation for our Electric HydroPulse® and other automatic spray nozzles. These plug-and-play controllers are an elegant solution for precision coating, moistening, and lubricating applications.

Consider the FlexFlow for any industrial process where expensive compounds or ingredients need to be sprayed directly onto the process target. Each control panel can be used as a standalone system – or upgrade to the 2000 model to integrate with your existing plant operations. Discover optimal spray performance for applying flavorings, coatings, mold inhibitors, antimicrobials, preservatives, release agents, and moisturizers with exceptional accuracy.



### FLEXFLOW™ 1000

- HMI touch screen includes intuitive operations for streamlined control and diagnostic overview for troubleshooting
- Operate up to 12 nozzles
- Two zones of precision control
  - Operate up to 6 nozzles in each zone
  - Zones 1 and 2 can be programmed with independent or synchronous settings



### FLEXFLOW™ 2000

The FlexFlow 2000 offers ultimate system flexibility by managing up to 20 spray nozzles in up to 20 independently controlled spray zones. With individual spray zone assignment for each nozzle, you can group nozzles into as many zones as needed to accomplish your spray process objectives.

- HMI touch screen includes intuitive operations for streamlined control and diagnostic overview for troubleshooting
- Match spray volume to conveyor speed with auto-adjust duty cycle
- Extremely flexible in zone operations – can operate up to 20 nozzles with up to 20 triggers in up to 20 zones
- Ethernet port for process integration
- Three versions available with an easy upgrade path:
  - Model 2010 operates up to 10 nozzles
  - Model 2016 operates up to 16 nozzles
  - Model 2020 operates up to 20 nozzles

TO ORDER: specify pipe size, connection type, nozzle number, spray angle, and material.

# COMPATIBLE AUTOMATIC SPRAY NOZZLES

## HYDROPULSE® - ELECTRIC - EHP - FOOD GRADE HYGIENIC

<b>Liquid inlet connection</b>	1/8", NPT or BSPP; or 1/2" Tri-clamp
<b>Maximum liquid flow rate</b>	1.0 GPM / 3.8 LPM
<b>Maximum rated pressure</b>	250 PSI / 17 bar
<b>Thermal insulation class</b>	F (155°C / 311°F)
<b>Power</b>	9.3W @ 24VDC
<b>Electrical Connector</b>	M8 3-pin
<b>Maximum cycle frequency</b>	150 cycles/sec
<b>Nozzle construction</b>	Stainless steel wetted components, Food grade Viton® (FKM) seals, hygienic design
<b>Interchangeable BJ, BJH, and CW nozzle tip options.</b>	



## HYDROPULSE® - ELECTRIC - EHPI - INDUSTRIAL DESIGN

<b>Liquid inlet connection</b>	1/8", NPT or BSPP
<b>Maximum liquid flow rate</b>	1.0 GPM / 3.8 LPM
<b>Maximum rated pressure</b>	300 PSI / 20 bar
<b>Thermal insulation class</b>	F (155°C / 311°F)
<b>Power</b>	10.4W @ 24VDC
<b>Electrical Connector</b>	DIN 11mm
<b>Maximum cycle frequency</b>	50 cycles/sec
<b>Nozzle construction</b>	Stainless steel wetted components, Viton® (FKM) seals
<b>Interchangeable BJ, BJH, and CW nozzle tip options.</b>	



### BENEFITS

- Precision volume sprays directly on the target
- Reduced waste and minimal over spray maintains a clean, safe environment
- Uniform and repeatable coverage improves product consistency
- Each nozzle provides a wide range of flow rates



# FEATURES AND UPGRADES

The BETE FlexFlow™ spray controllers are standalone electrical control panels intended to provide user-friendly control of BETE Electric HydroPulse (EHP/EHPI) series electric-actuated spray nozzles.



A Siemens brand Programmable Logic Controller (PLC) and associated hardware operates the nozzles. Spray zones can be triggered manually or they can be triggered automatically using digital inputs from process sensors. User-adjustable signal delays provide the most accurate spray timing functionality.

The spray flow rate can also be electronically controlled by pulsing the sprays while adjusting the ratio of ON versus OFF dwell time within each cycle. Pulsing at high frequency allows the average flow rate to be adjusted while maintaining constant fluid supply pressure and the appearance of continuous, uniform coverage. This flow control process is known as Pulse Width Modulation (PWM).

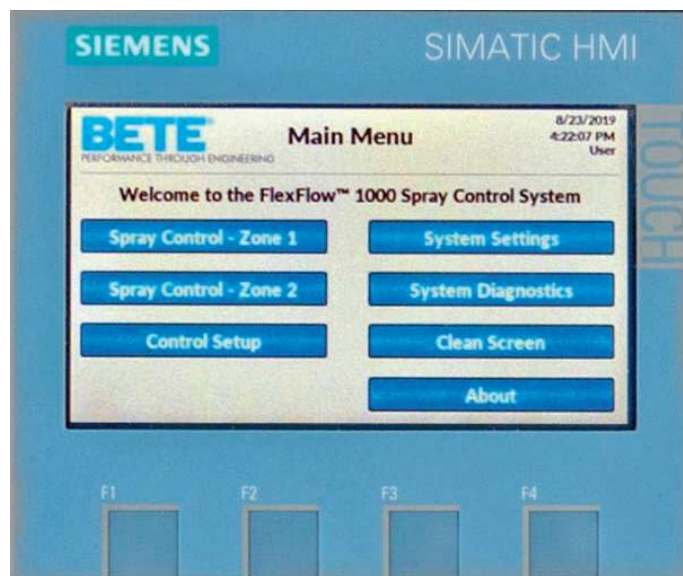

A touchscreen Human Machine Interface (HMI) allows users to configure the spray system and adjust spray parameters through an easy-to-navigate menu of options. Adjustable parameters for each spray zone include nozzle cycle rate, duty cycle, trigger signal delays, and trigger state.

TO ORDER: specify pipe size, connection type, nozzle number, spray angle, and material.

# FEATURES AND UPGRADES



A cable gland plate comes standard with every FlexFlow control panel. Only pierce as many openings as needed through the membrane for easy access to field wiring.



The FlexFlow 2000 includes an Ethernet port for process integration with your existing plant operations.



A hygienic enclosure upgrade is available for any FlexFlow System.

Hygienic enclosures feature special crevice-free door seals and hardware to eliminate product buildup. An angled roof design prevents objects from being deposited on top of the enclosure and also allows fluids to drain off rapidly. Door hinges are installed inside of the sealing zone leaving the outside exceptionally easy to clean and optional wall spacers create space for easy cleaning behind the enclosure.



Hygienic enclosure wall-mounts are an available upgrade add-on. These standoffs are an optional accessory for hygienic enclosures to provide access for cleaning in the space between the back of the panel and a wall.

# HydroPulse®

Food Grade Hygienic Design/ EHP and Industrial Design/ EHPI

## DESIGN FEATURES

- Interchangeable spray tips
- Electrically actuated for crisp on/off spray
- Mounting brackets available
- EHP features straight through porting for in-series set-up

## SPRAY CHARACTERISTICS

- Precision volume sprays directly on the target
- Reduced waste and minimal overspray maintain a clean, safe environment
- Uniform and repeatable coverage improves product consistency

**Spray pattern:** Spray Patterns: Flat Fan, Full Cone, Hollow Cone

**Spray angles:** 0° to 120°

**Flow rate:** 0.038 to 3.8 L/min

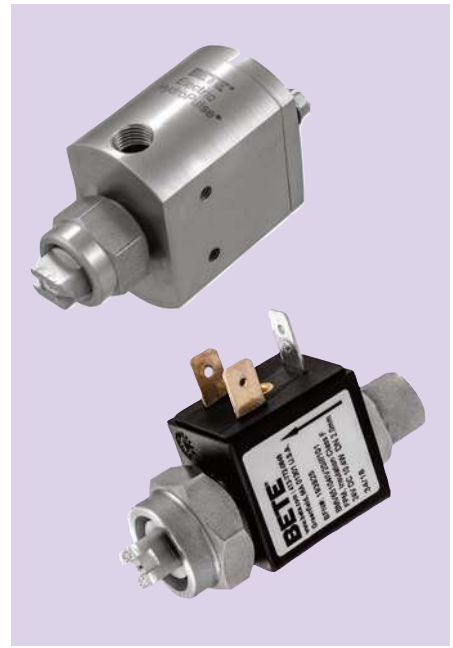

AUTOMATIC

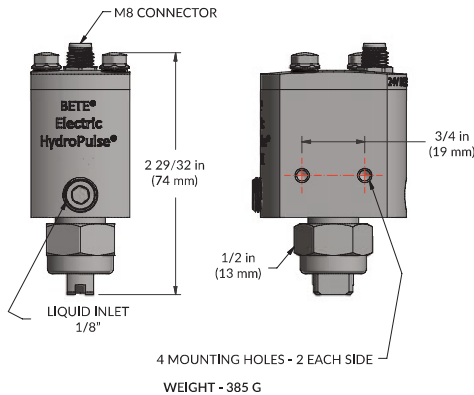
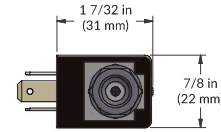
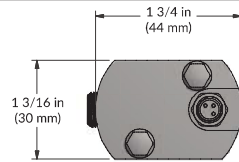

WEIGHT - 385 G

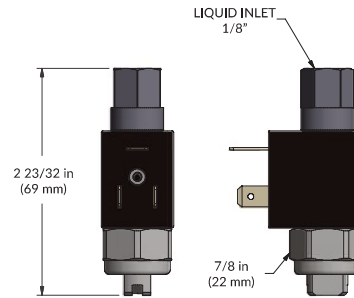

WEIGHT - 115 G

## Flow Rates of BJ (Fan) Tips on EHP and EHPI Bodies, L/min\*



0°, 15°, 25°, 40°, 50°, 65°, 80°, 95°, 110° Spray Angles, Standard Materials 303 and 316 Stainless Steel

	Nozzle Inlet Pressure, bar							
	0.3	0.5	1	2	3	5	10	15
**BJ0067	0.083	0.11	0.15	0.21	0.26	0.34	0.49	0.61
BJ01	0.12	0.16	0.22	0.31	0.38	0.49	0.72	0.87
BJ015	0.18	0.23	0.33	0.45	0.57	0.76	1.1	1.3
BJ02	0.23	0.3	0.42	0.61	0.76	0.98	1.4	1.7
BJ03	0.34	0.45	0.61	0.87	1.1	1.4	2	2.5
BJ04	0.42	0.57	0.79	1.1	1.4	1.8	2.5	3.1
BJ05	0.53	0.68	0.95	1.3	1.6	2	2.9	3.5
BJ06	0.61	0.76	1.1	1.5	1.8	2.3	3.2	3.8
BJ08	0.72	0.91	1.2	1.7	2	2.6	3.6	
BJ10	0.79	0.98	1.4	1.9	2.2	2.8	3.8	
BJ15	0.95	1.1	1.5	2	2.4	3	3.8	
BJ20	0.98	1.2	1.6	2.1	2.5	3.1		
BJ30	1.1	1.3	1.7	2.2	2.6	3.1		

\*\*Only available in angles up to and including 65°

TO ORDER: specify pipe size, connection type, nozzle number, spray angle, and material.

**Flow Rates of CW (Full or Hollow Cone) Tips on EHP and EHPI Bodies, L/min\***  
 80° and 120° Spray Angles, Standard Materials 303 and 316 Stainless Steel

	Nozzle Inlet Pressure, bar							
	0.3	0.5	1	2	3	5	10	15
								
CW-25F	0.31	0.38	0.53	0.76	0.91	1.2	1.7	2
CW-50F	0.53	0.68	0.95	1.3	1.6	2	2.8	3.4
CW-75F	0.72	0.91	1.2	1.7	2	2.6	3.5	
CW-100F	0.83	1	1.4	1.9	2.2	2.8	3.8	
								
CW-25H	0.31	0.38	0.53	0.76	0.91	1.2	1.7	2
CW-50H	0.53	0.68	0.95	1.3	1.6	2	2.8	3.4
CW-75H	0.72	0.91	1.2	1.7	2	2.6	3.5	
CW-100H	0.83	1	1.4	1.9	2.2	2.8	3.8	



**AUTOMATIC**

**Flow Rates of BJH (Fan) Tips on EHP and EHPI Bodies, L/min\***

5° to 120° Spray Angles, Tungsten Carbide Insert with 303 Stainless Steel Housing

	Nozzle Inlet Pressure, bar				
	2	3	5	10	15
					
BJH-0.18			0.038	0.057	0.068
BJH-0.28			0.098	0.14	0.17
BJH-0.38			0.18	0.25	0.31
BJH-0.45	0.16	0.19	0.25	0.35	0.42
BJH-0.53	0.21	0.26	0.33	0.45	0.57
BJH-0.66	0.33	0.42	0.53	0.72	0.91
BJH-0.78	0.45	0.57	0.72	1	1.2
BJH-0.89	0.57	0.72	0.91	1.3	1.6
BJH-0.99	0.72	0.87	1.1	1.6	2
BJH-1.14	0.95	1.1	1.5	2	2.5
BJH-1.29	1.1	1.4	1.8	2.5	3
BJH-1.45	1.4	1.7	2.1	2.9	3.5
BJH-1.60	1.5	1.9	2.3	3.2	3.8
BJH-1.80	1.7	2	2.6	3.5	
BJH-1.91	1.8	2.2	2.7	3.7	



*Tungsten carbide orifice inserts for maximum wear resistance and service life.*

\* Maximum flows shown above. Flow rates can be turned down to 5% of listed value using PWM (Pulse Width Modulation). Contact BETE for details.

CALL 413-772-0846  
 Call for the name of your nearest BETE representative.

# HydroPulse®

PHP - Pneumatically Actuated - BJ & BJH Flat Fan - CW Full/Hollow Cone - ST Full Cone



## DESIGN FEATURES

- Interchangeable spray tips
- Pneumatically actuated for crisp on/off spray
- Mounting brackets available
- Straight through porting for in-series set-up

## SPRAY CHARACTERISTICS

- Precision volume sprays directly on the target
- Reduced waste and minimal overspray maintain a clean, safe environment
- Uniform and repeatable coverage improves product consistency

**Spray pattern:** Flat Fan, Full Cone, Hollow Cone

**Spray angles:** 0° to 120°

**Flow rate:** 0.048 to 57.7 L/min

AUTOMATIC

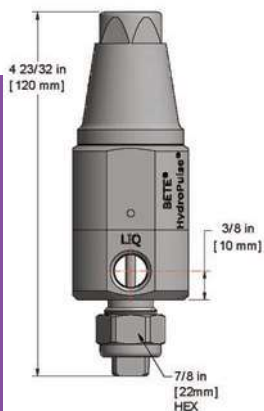
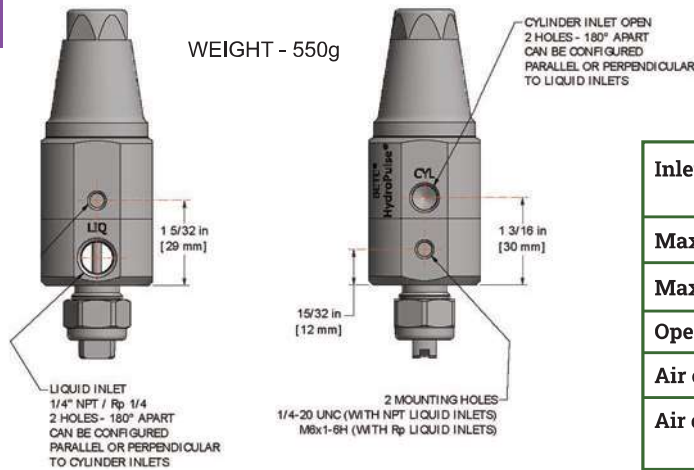

<b>Inlet connections</b>	¼" NPT or BSPP, liquid; ⅝" NPT or BSPP, cylinder air; ½" or DN10 tri-clamp
<b>Maximum flow rate</b>	57.7 LPM
<b>Maximum rated liquid pressure</b>	42 bar
<b>Operating temperature range</b>	-26°C to 204°C
<b>Air cylinder pressure</b>	2 bar to 17 bar
<b>Air cylinder operation</b>	Single acting (spring return) or double acting.
<b>Maximum cycle frequency</b>	50 cycles/sec
<b>Nozzle construction</b>	Stainless steel wetted components Viton® (FKM) seals
<b>Interchangeable BJ, BJH, CW, and ST nozzle tip options.</b>	

## CW Flow Rates and Dimensions

Full Cone and Hollow Cone, 80° and 120° Spray Angles

Nozzle Number	K Factor	LITERS PER MINUTE @ BAR								Approx. Orifice Dia.(mm)
		0.5 bar	0.7 bar	1 bar	2 bar	3 bar	5 bar	10 bar	15 bar	
CW25	0.587	0.424	0.497	0.587	0.814	0.984	1.25	1.73	2.10	1.14
CW50	1.17	0.848	0.993	1.17	1.63	1.97	2.50	3.47	4.19	1.37
CW75	1.76	1.27	1.49	1.76	2.44	2.95	3.75	5.20	6.29	1.60
CW100	2.35	1.70	1.99	2.35	3.25	3.94	5.01	6.93	8.39	2.18

$$\text{Flow Rate ( l/min )} = K ( \text{bar} )^{0.47}$$

**Standard Materials: Brass, 303 Stainless Steel, and 316 Stainless Steel.**

Spray angle performance varies with pressure. Contact BETE for specific data on critical applications.

TO ORDER: specify pipe size, connection type, nozzle number, spray angle, and material.

## ST Flow Rates and Dimensions

Full Cone, 90° (FCN) and 120° (FC) Spray Angles



Nozzle Number	K Factor	LITERS PER MINUTE @ BAR								Approx. (mm) Orifice Dia.
		0.5 bar	0.7 bar	1 bar	2 bar	3 bar	5 bar	10 bar	20 bar	
ST6	3.19	2.26	2.67	3.19	4.5	5.5	7.1	10.1	14.3	2.38
ST8	5.93	4.19	4.96	5.93	8.4	10.3	13.2	18.7	26.5	3.18
ST10	9.12	6.45	7.63	9.12	12.9	15.8	20.4	28.8	40.8	3.97

$$\text{Flow Rate (l/min)} = K \sqrt{\text{bar}}$$

Standard Materials: 316 Stainless, Cobalt Alloy 6

## BJ Flow Rates

Fan, 0°, 15°, 25°, 40°, 50°, 65°, 80°, 95°, 110° Spray Angles



	K Factor	Nozzle Inlet Pressure, bar								Equiv. Orifice Diameter (mm)	Standard Available Spray Angles*	
		0.3	1	2	5	10	20	40				
BJ 0067	0.153	0.084	0.153	0.220	0.340	0.480	0.680	0.970	0.580	0, 15, 25, 40, 50, 65, 80		
BJ 01	0.228	0.120	0.228	0.320	0.510	0.720	1.02	1.44	0.710	0, 15, 25, 40, 50, 65, 80, 95, 110		
BJ 015	0.342	0.190	0.342	0.480	0.760	1.08	1.53	2.16	0.970	0, 15, 25, 40, 50, 65, 80, 95, 110		
BJ 02	0.456	0.250	0.456	0.640	1.02	1.44	2.04	2.88	0.990	0, 15, 25, 40, 50, 65, 80, 95, 110		
BJ 03	0.684	0.370	0.684	0.970	1.53	2.16	3.06	4.32	1.19	0, 15, 25, 40, 50, 65, 80, 95, 110		
BJ 04	0.912	0.500	0.912	1.29	2.04	2.88	4.08	5.77	1.40	0, 15, 25, 40, 50, 65, 80, 95, 110		
BJ 05	1.14	0.620	1.14	1.61	2.55	3.60	5.10	7.21	1.55	0, 15, 25, 40, 50, 65, 80, 95, 110		
BJ 06	1.37	0.750	1.37	1.93	3.06	4.32	6.11	8.65	1.70	0, 15, 25, 40, 50, 65, 80, 95, 110		
BJ 08	1.82	1.00	1.82	2.58	4.08	5.77	8.15	11.5	1.88	0, 15, 25, 40, 50, 65, 80, 95, 110		
BJ 10	2.28	1.25	2.28	3.22	5.10	7.21	10.2	14.4	2.18	0, 15, 25, 40, 50, 65, 80, 95, 110		
BJ 15	3.42	1.87	3.42	4.83	7.64	10.8	15.3	21.6	2.72	0, 15, 25, 40, 50, 65, 80, 95, 110		
BJ 20	4.56	2.5	4.56	6.45	10.2	14.4	20.4	28.8	3.18	0, 15, 25, 40, 50, 65, 80, 95, 110		
BJ 30	6.84	3.74	6.84	9.67	15.3	21.6	30.6	43.2	3.67	0, 15, 25, 40, 50, 65, 80, 95, 110		
BJ 40	9.12	4.99	9.12	12.9	20.4	28.8	40.8	57.7	3.97	0, 15, 25, 40, 50, 65, 80, 95, 110		

$$\text{Flow Rate (l/min)} = K \sqrt{\text{bar}}$$

BJ tip materials: Brass, 303SS, 316SS

## BJH Flow Rates and Dimensions

5° to 120° Spray Angles, Tungsten Carbide Insert with 303 Stainless Steel Housing

	K Factor	LITERS PER MINUTE @ BAR					Equivalent Orifice Dia. (mm)	Available Spray Angles	
		2 bar	3 bar	4 bar	7 bar	30 bar			
BJH-0.18	0.018	-	-	-	0.048	0.099	0.18	5°, 10°, 15°, 20°, 25°, 30°, 33°, 40°, 50°	
BJH-0.28	0.043	-	-	-	0.114	0.236	0.28	5°, 10°, 20°, 33°, 40°, 50°, 65°, 73°	
BJH-0.38	0.079	-	-	-	0.209	0.433	0.38	10°, 20°, 33°, 40°, 50°, 65°, 73°, 80°, 90°, 100°	
BJH-0.45	0.110	-	-	-	0.291	0.602	0.45	10°, 20°, 33°, 40°, 50°, 65°, 73°, 80°, 90°, 100°, 110°, 120°	
BJH-0.53	0.152	0.215	0.263	0.304	0.402	0.833	0.53	100°, 110°, 120°	
BJH-0.66	0.237	0.335	0.410	0.474	0.627	1.30	0.66		
BJH-0.78	0.330	0.467	0.572	0.660	0.873	1.81	0.78	10°, 20°, 33°, 40°, 50°, 65°, 73°, 80°, 90°, 100°, 110°, 120°	
BJH-0.89	0.430	0.608	0.745	0.860	1.14	2.36	0.89		
BJH-0.99	0.532	0.752	0.921	1.06	1.41	2.91	0.99		
BJH-1.14	0.706	0.998	1.22	1.41	1.87	3.87	1.14	20°, 33°, 40°, 50°, 65°, 73°, 80°, 90°, 100°, 110°, 120°	
BJH-1.29	0.904	1.28	1.57	1.81	2.39	4.95	1.29		
BJH-1.45	1.14	1.61	1.97	2.28	3.02	6.24	1.45	20°, 33°, 40°, 50°, 65°, 73°, 80°, 90°, 100°, 110°, 120°	
BJH-1.60	1.39	1.97	2.41	2.78	3.68	7.61	1.60	20°, 33°, 40°, 50°, 65°, 73°, 80°, 90°, 100°, 110°, 120°	
BJH-1.80	1.76	2.49	3.05	3.52	4.66	9.64	1.80	20°, 33°, 40°, 50°, 65°, 73°, 80°, 90°, 100°, 110°, 120°	
BJH-1.91	1.98	2.80	3.43	3.96	5.24	10.8	1.91	20°, 33°, 40°, 50°, 65°, 73°, 80°, 90°, 100°, 110°, 120°	

$$\text{Flow Rate (l/min)} = K \sqrt{\text{bar}}$$

Standard Materials: Tungsten Carbide Insert with 303 Stainless Steel Housing

Spray angle performance varies with pressure. Contact BETE for specific data on critical applications.

AUTOMATIC

CALL 413-772-0846  
Call for the name of your nearest BETE representative.