

# SF

## Snap Release Nozzle System

### DESIGN FEATURES

- Nozzles can be quickly changed and aligned by hand without tools
- Clamp-on adapter fits any style nozzle
- Quick set-up system features special "Snap-in" tips
- Polypropylene, resistant to most acids and alkalis
- Double clamp base or adapter available for higher pressure operation

### SPRAY CHARACTERISTICS

- Quick Set-up System can be provided with fan, hollow or full cone spray tips
- Full 45° alignment of spray without tools

### More SF Nozzle Systems:

Hollow Cone: page 56

Flat Fan: page 74

**Flow rates:** 1.61 to 75.6 l/min

**Spray angles:**

**Full Cone:** 35°, 65°, 80°

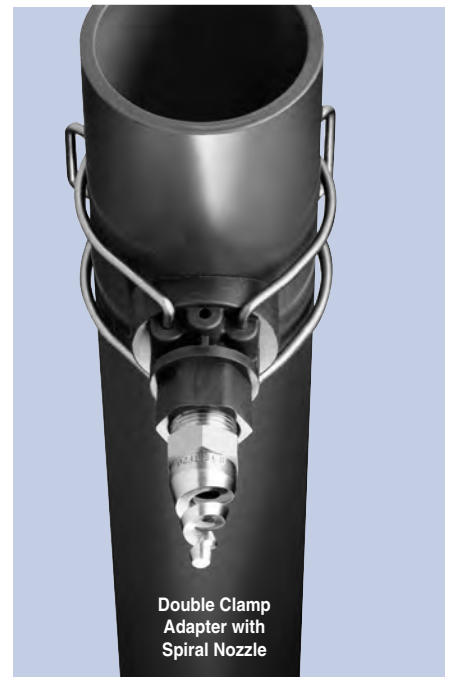

FULL CONE



80° Full Cone

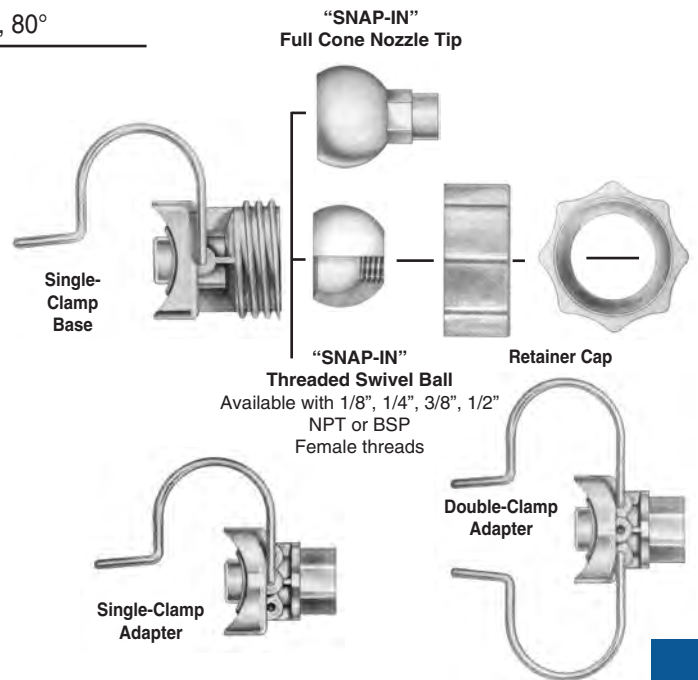
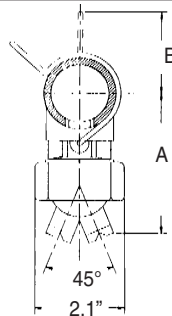

### CLAMP-ON ADAPTER

- Available for 1", 1-1/4", 1-1/2" and 2" pipe.
- Available with 1/8", 1/4", 3/8", 1/2" NPT female threads; or 1/8" BSP female threads
- Available with single or double clamp.
- **TO ORDER ADAPTER Specify: Pipe Size, thread size, thread type, number of clamps, materials.**

### SF Flow Rates and Dimensions

SF Full Cone 35°, 65° and 80° Spray Angles 1", 1-1/4", 1-1/2" and 2"

Nozzle Number	Available Spray Angle	K Factor	LITERS PER MINUTE @ BAR								Pipe Size	Body Color	Approx Dim. (mm)		Wt. (g)
			0.5 bar	0.7 bar	1 bar	2 bar	3 bar	5 bar	7 bar	10 bar			A	B	
SF31FC	35°	7.596	5.45	6.40	7.60	10.6	12.9	16.4	19.3	22.9	1"	blue	83.8	43.2	62.4
SF32FC	80°	7.855	5.63	6.62	7.86	11.0	13.3	17.0	20.0	23.7	1-1/4"	red	86.4	48.3	62.4
SF102FC	65°	25.02	17.9	21.1	25.0	34.9	42.4	54.2	63.7	75.6	1-1/2"	purple	91.4	50.8	62.4
											2"	green	94.0	55.9	62.4

$$\text{Flow Rate (l/min)} = K (\text{bar})^{0.48}$$

**Standard Materials:** Polypropylene, 302 Stainless Steel clamp, EPDM seal.

**Optional Materials:** 303 Stainless Steel clamp, Viton seal.

**NOTE:** Drill 16.7mm (21/32") hole in pipe to install SF.

**NOTE:** Maximum recommended pressures for SF assemblies: With single clamp 5 bar for 1" pipe; 3.5 bar for 1-1/4" and 1-1/2" pipe; and 2 bar for 2" pipe; with double clamp up to 10 bar.

Spray angle performance varies with pressure. Contact BETE for specific data on critical applications.